

Platinum

Modern Chef

La cocina perfecta

Lista de piezas

MG28AR-PLA

**¿FREEZER O
REFRIGERADOR?**

MG28AF-PLA

Un producto:

METALGAS, S.R.L.

Calidad, servicio y garantía

Más de 35 años acompañando tus negocios

📍 Av. Luperón no.5, Zona Industrial de Herrera
📍 Autopista de San Isidro, 1^{er} nivel Coral Mall. Santo Domingo Este

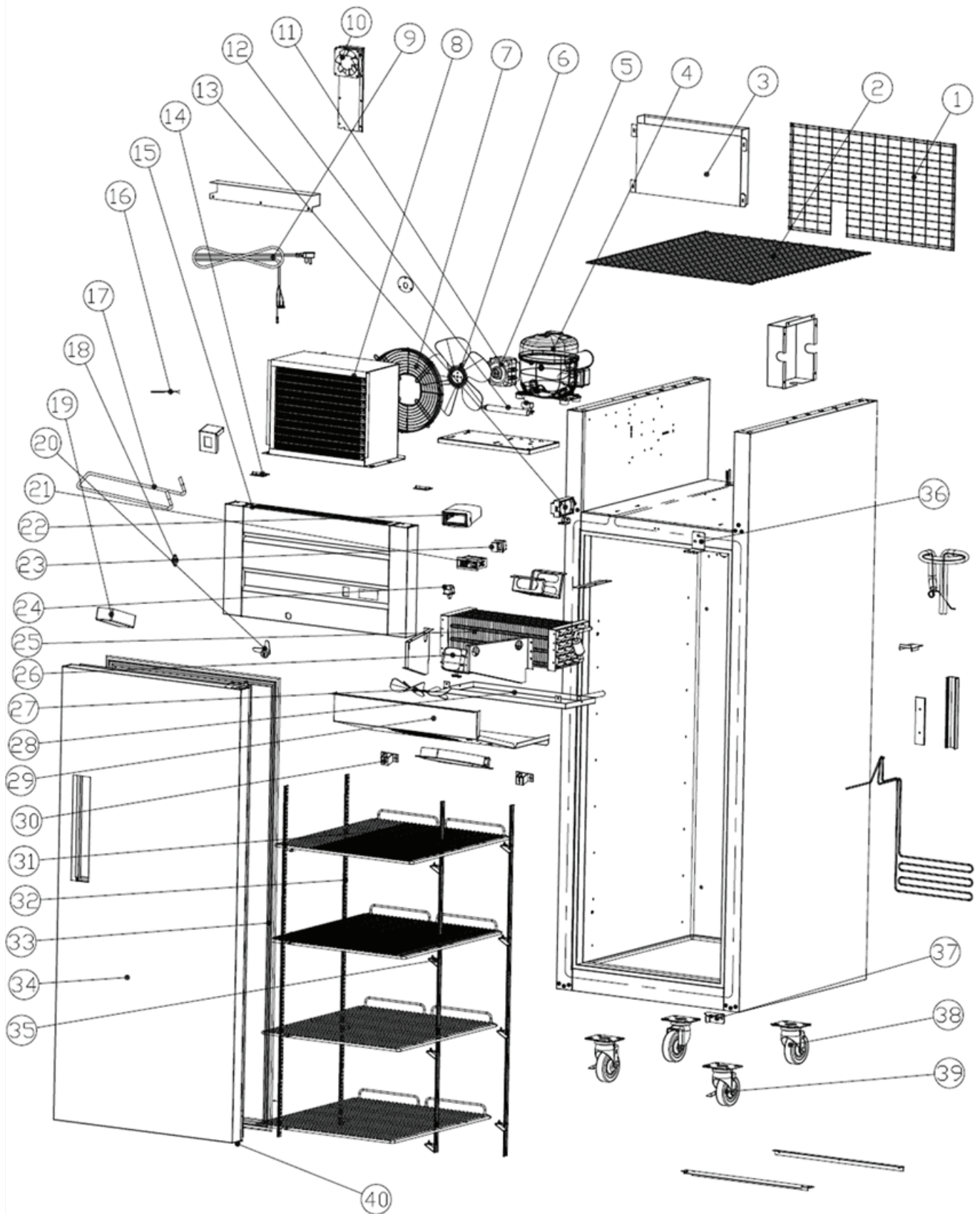



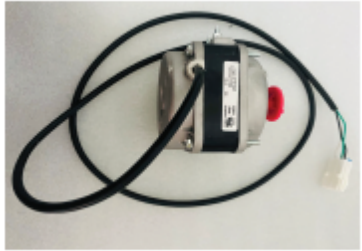
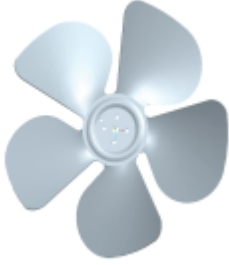
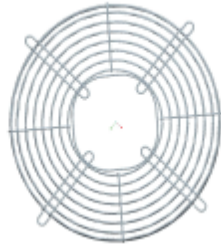
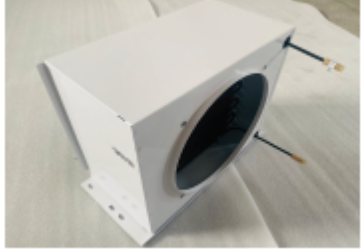
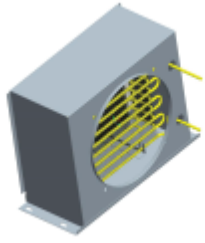

No.	Number	Description	Photo
1	R4.04.30033	Back Grid; US Market Bottom mounted Freezers and Refrigerators; 720*633	
2	R4.04.30036	Top Grid; US Market Top-mounted Freezers and Refrigerators; 633*350	
3	R7.01.10083	Outer Drain Pan (400*30)	
4	R2.01.20005	Compressor; NPY14LR	
4	R2.01.20001	Compressor; NUT45NR	



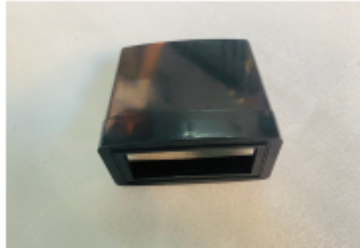

5	R2.02.10003	Fan Motor YZ16-25	
6	R4.07.10007	Fan Blade ø 254; 28°	
7	R4.04.50003	Fan Guard, ø254; 40H	
8	R5.02.20050	Condenser; 6 layers; 345L285H	
8	R5.02.20051	Condenser; 5 layers; 345L285H	

9	R2.09.10003	<p>Wiring Harness; Power Cord; NEMA 5-15P; 3*16AWG; 2.7M</p>	
10	R2.02.20007	<p>Fan Motor SAA12038B2H</p>	
11	R4.99.10019	<p>Filter Clip</p>	
12	R5.03.20003	<p>Filter Drier; Bypass $\Phi 2.5 \times 6.2-135$</p>	
13	R2.08.10001	<p>Junction Box; ET0301G; UL Certified</p>	

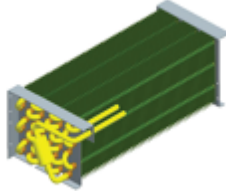
14	R4.09.10001	Fixed Hinge	
15	R7.01.10033	Front Panel D28AF	
16	R2.11.10006	Probe Wire; 3435/10K Ω ; 2.5M/With Terminals/Black	
16	R2.11.10001	Probe Wire; 3435/10K Ω ; 2.5M/No Terminals/White	
16	R2.11.10005	Probe Wire; 3435/10K Ω ; 2.5M/No Terminals/Black	

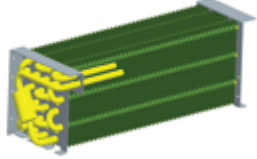
17	R2.06.10010	Electric Heating Parts; Tube; DA400L75B_1	
18	R2.03.20007	Thermostats; Mechanical; T1/11-50/40/A912B14 H131	
19	R2.05.10001	Filament Lamp 115V	
20	R4.11.10005	Lock (Spring Bolt Length:45)	
21	R2.03.10001	Thermostat XR03CX-4N6F7	

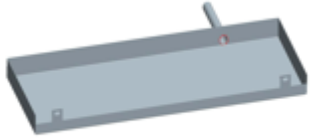
21	R2.03.10003	Termostat XR06CX-4N0F7	
22	R3.01.10008	Termostat Water Proof Cover; 95*95	
23	R2.07.10001	Switch; Navicular; HY12-9; 2HP	
24	R2.07.20001	Switch; Travel Switch; HC-050K; 10A	
25	R5.01.10044	Evaporator; CG-6R6K380L	

25	R5.01.10038	Evaporator; CG-6R4K380L	
26	R2.02.10001	Fan Motor YZ6-13	
27	R4.07.10003	Fan Blade ø 200; 28°	
28	R7.01.10042	Inner Water Pan D28AF	
29	R7.01.10076	Evaporator Cover D28AF	

30	R7.01.10100	Evaporator Cover Supporting Bracket	
31	R4.04.10091	Shelf; US Market Freezers and Refrigerators 532*598_F	
32	R4.06.20004	K-strip; 8 holes; Length:115 2.7	
33	R7.01.10098	685 Gasket (Top-mounted)	
34	R7.01.10038	685 Right Door (Top-mounted)	

35	R4.06.10001	K-clip; 22*27.2	
36	R4.02.10017	Hinge; S/S; Upper; 46*57; Compatible with All Reach-in Freezers and Refrigerators	
37	R4.02.10021	Hinge; S/S; Lower Right; 60*32; Compatible with All Reach-in Freezers and Refrigerators	
38	R4.03.10012	4 Inches Nylon Wheel; A2-100S-102	
39	R4.03.10013	4 Inches Nylon Wheel with Brake; A2-100S3-102	

40	R4.08.30001	Self-closing Hinge; 22*22*100	
----	-------------	----------------------------------	---



Un producto:



Calidad, servicio y garantía

Más de 35 años acompañando tus negocios

 Av. Luperón no.5, Zona Industrial de Herrera
 Autopista de San Isidro, 1^{er} nivel Coral Mall. Santo Domingo Este