

Platinum

Modern Chef
La cocina perfecta

*Lista de piezas mesa refrigerada de preparación de pizza de dos puertas
MGPP70-PLA*

**MESA
REFRIGERADA
PREPARACIÓN
DE PIZZA**



WWW.METALGAS.COM.DO

Un producto:

METALGAS, S.R.L.

Calidad, servicio y garantía



Más de 35 años acompañando tus negocios

 Av. Luperón no.5, Zona Industrial de Herrera
 Autopista de San Isidro, 1^{er} nivel Coral Mall. Santo Domingo Este

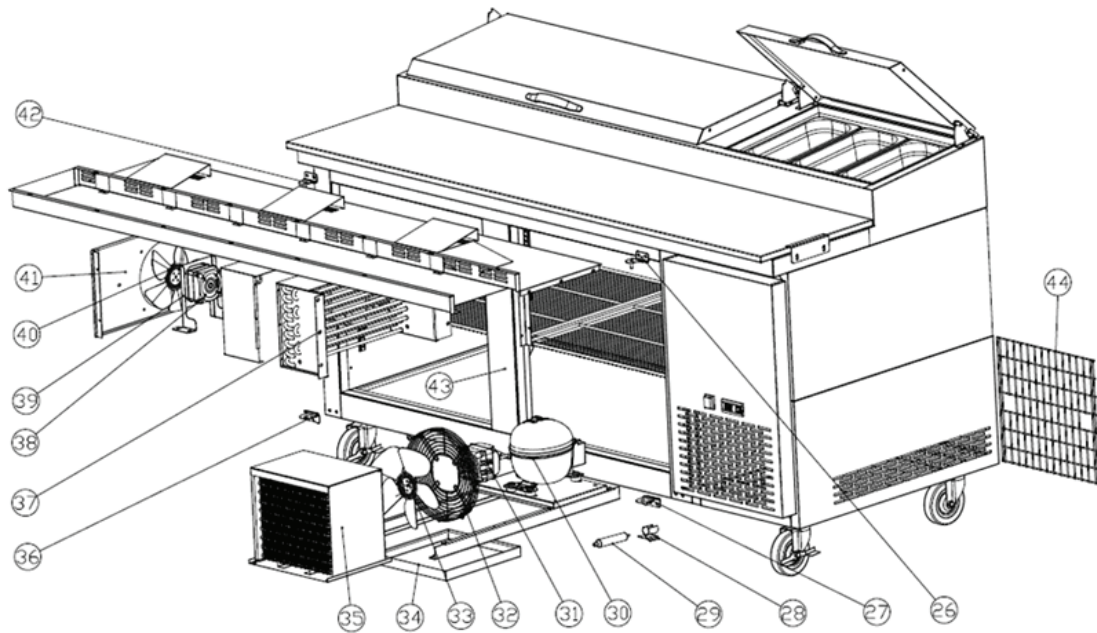
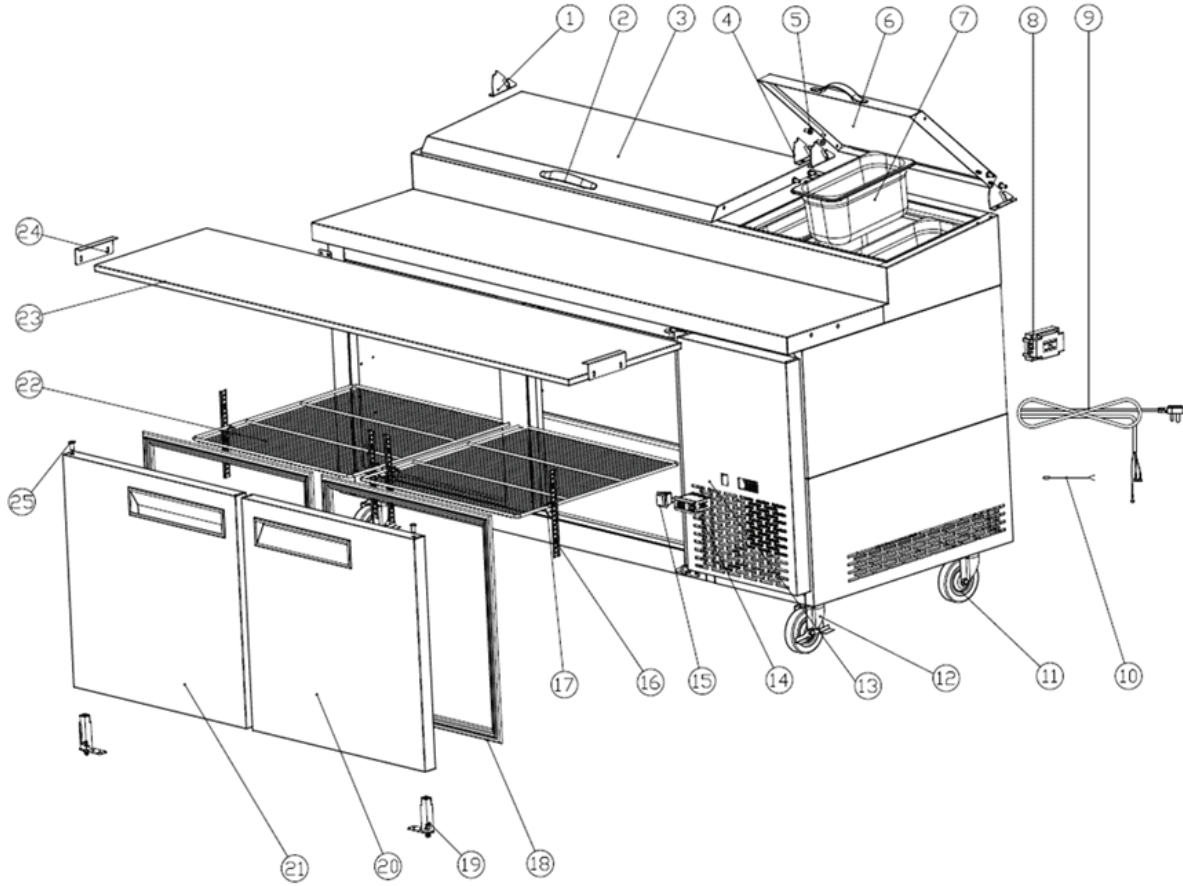
MGPP70-PLA





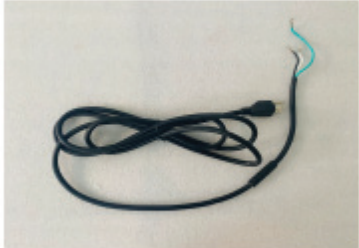



NO.	Number	Description	Photo
1	R4.02.10033	Hinge; S/S; Pan Cover Left Hinge; 85*18	
2	R4.12.40001	Handle; Locating Distance 128	
3	R7.01.40036	Pan Cover DPP44/DPP70/DPP90	
4	R4.02.10034	Hinge; S/S; Pan Cover Right Hinge; 85*18	
5	R4.02.10036	Hinge; S/S; Pan Cover Pin (Blindhole); 20L	

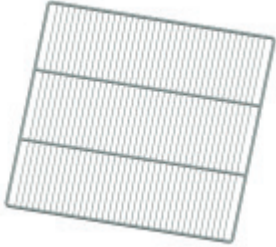

6	R7.01.40037	Right Pan Cover Assemblies DPP70	
7	R3.01.40003	1/3 GN Pan with Lid; H150	
8	R2.08.10001	Junction Box; ET0301G; UL Certified	
9	R2.09.10003	Wiring Harness; Power Cord; NEMA 5-15P; 3*16AWG; 2.7M	
10	R2.11.10006	Probe Wire; 3435/10K Ω ; 2.5M/With Terminals/Black	



11	R4.03.10014	5 Inches Black PP Wheel; A2-125S-102	
12	R4.03.10015	5 Inches Black PP Wheel with Brake; A2-125S3-102	
13	R7.01.40049	Front Panel DPP70/DPP90	
14	R2.03.10001	Thermostat XR03CX-4N6F7	
15	R2.07.10001	Switch; Navicular; HY12-9; 2HP	



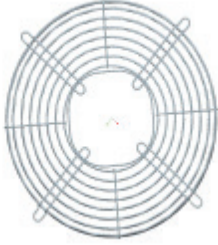

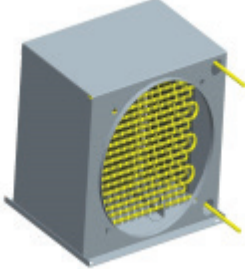
16	R4.06.20001	K-strip; 2 holes; Length:238.3	
17	R4.06.10001	K-clip; 22*27.2	
18	R7.01.40043	Gasket DPP70/Left, Middle Door (DPP90)	
19	R4.08.30001	Self-closing Hinge; 22*22*100	
20	R7.01.40040	Right Door Assemblies DPP70/Middle Door Asse. DPP90	

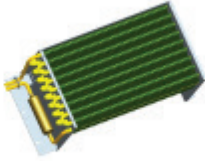
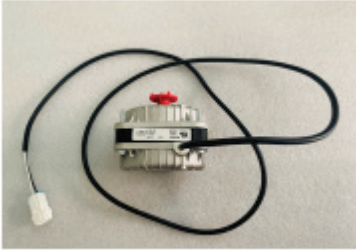
21	R7.01.40039	Left Door Assemblies DPP70/DPP90	
22	R4.04.10073	Shelf; DPP70/DPP90 (Left); 595*610	
23	R3.03.10010	Cutting Board; 1774*480*15	
24	R7.01.40045	Fixed Block for Cutting Board	
25	R3.01.50008	Axis Guide; Nylon; ϕ 7*25	

26	R4.02.10002	<p>Hinge; S/S; Upper Right; 45*23; Compatible with All Undercounters and Salad Prep Tables</p>	
27	R4.02.10006	<p>Hinge; S/S; Lower Right; 50*26; Compatible with All Undercounters and Salad Prep Tables</p>	
28	R4.99.10019	Filter Clip	
29	R5.03.20003	<p>Filter Drier; Bypass Φ 2.5*6.2-135</p>	

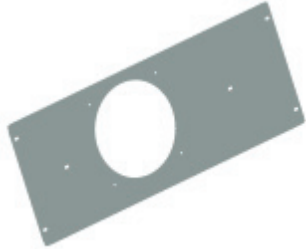
31	R2.02.10002	Fan Motor YZ10-20	
32	R4.04.50002	Fan Guard, \varnothing 230; 40H	
33	R4.07.10005	Fan Blade \varnothing 230; 28°	
34	R7.01.40051	Outer Water Pan DPP70/DPP90	
35	R5.02.20059	Condenser; 8 layers; 270L235H	

36	R4.02.10005	<p>Hinge; S/S; Lower Left; 50*26; Compatible with All Undercounters and Salad Prep Tables</p>	
37	R5.01.10003	<p>Evaporator; 3R9K400L</p>	
38	R2.02.10001	<p>Fan Motor YZ6-13</p>	
39	R7.01.40052	<p>Evaporator Fan Bracket</p>	
40	R4.07.10003	<p>Fan Blade ø 200; 28°</p>	

41	R7.01.40046	Evaporator Cover	
42	R4.02.10001	Hinge; S/S; Upper Left; 45*23; Compatible with All Undercounters and Salad Prep Tables	
43	R7.01.40047	Foaming Vertical Beam	
44	R4.04.30019	Back Grid; Pizza Prep Table; 363*343	

Un producto:



Calidad, servicio y garantía

Más de 35 años acompañando tus negocios

 Av. Luperón no.5, Zona Industrial de Herrera
 Autopista de San Isidro, 1^{er} nivel Coral Mall. Santo Domingo Este