

Platinum

Modern Chef
La cocina perfecta

*Lista de piezas mesa refrigerada preparación de sandwich
MGSP29*

**MESA
REFRIGERADA
PREPARACIÓN
DE SANDWICH**



WWW.METALGAS.COM.DO

Un producto:

METALGAS, S.R.L.

Calidad, servicio y garantía

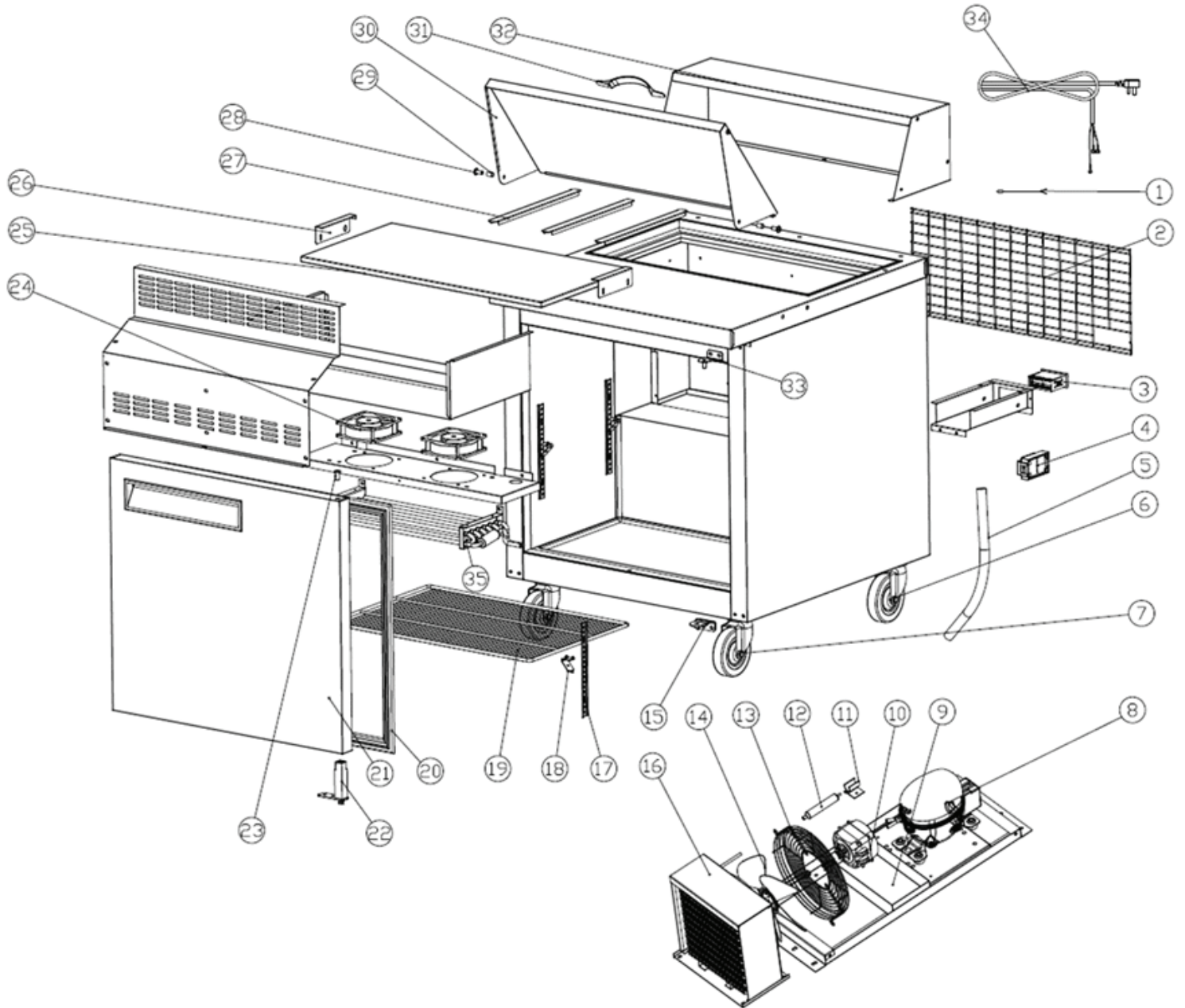

Más de 35 años acompañando tus negocios

 Av. Luperón no.5, Zona Industrial de Herrera
 Autopista de San Isidro, 1^{er} nivel Coral Mall. Santo Domingo Este

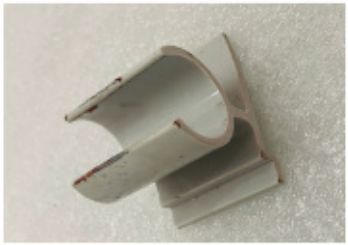
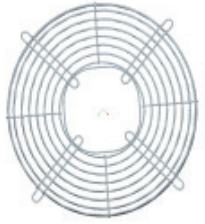

NO.	Number	Description	Photo
1	R2.11.10006	Probe Wire; 3435/10K Ω ; 2.5M/With Terminals/Black	
2	R4.04.30023	Back Grid; Salad Prep Table; 669*268	
3	R2.03.10001	Thermostat XR03CX-4N6F7	
4	R2.08.10001	Junction Box; ET0301G; UL Certified	
5	R7.01.40089	PVC Reticulated Duct; ϕ 23* ϕ 19*300	

6	R4.03.10014	5 Inches Black PP Wheel; A2-125S-102	
7	R4.03.10015	5 Inches Black PP Wheel with Brake; A2-125S3-102	
8	R2.01.20001	Compressor; NUT45NR	
9	R7.01.40053	Outer Water Pan DSP29/DUC29	
10	R2.02.10002	Fan Motor YZ10-20	



11	R4.99.10019	Filter Clip	
12	R5.03.20003	Filter Drier; Bypass $\Phi 2.5 \times 6.2-135$	
13	R4.04.50002	Fan Guard, $\Phi 230$; 40H	
14	R4.07.10005	Fan Blade $\phi 230$; 28°	
15	R4.02.10006	Hinge; S/S; Lower Right; 50*26; Compatible with All Undercounters and Salad Prep Tables	

16	R5.02.20048	Condenser; 240L 235H	
17	R4.06.20001	K-strip; 2 holes; Length:238.3	
18	R4.06.10001	K-clip; 22*27.2	
19	R4.04.10078	Shelf; TFP29; 620* 410	
20	R7.01.40062	Gasket DSP29/DUC29	

21	R7.01.40054	Right Foaming Door DSP29/DUC29	
22	R4.08.30001	Self-closing Hinge; 22*22*100	
23	R3.01.50008	Axis Guide; Nylon; φ 7*25	
24	R2.02.20007	Fan Motor SAA12038B2H	
25	R3.03.10005	Cutting Board; 736*370*15	

25	R3.03.10001	Cutting Board; 736*225*15	
26	R7.01.40066	Left Fixed Block for Cutting Board	
27	R7.01.40070	Vertical GN Pan Bracket; 352L; DSP29-8	
27	R7.01.40068	Vertical GN Pan Bracket; 529L; MEGA_TOP	
28	R4.02.10035	Hinge; S/S; Pan Cover Pin (Throughhole); 20L	

29	R4.99.10023	Limit Tube for Pan Cover; $\phi 10^* \phi 9^*15$	
30	R7.01.40071	Pan Cover DSP29-8	
30	R7.01.40076	Pan Cover DSP29-12M/DSP60-24M (Left)	
31	R4.12.40001	Handle; Locating Distance 128	
32	R7.01.40079	Back Cover; DSP29-8	

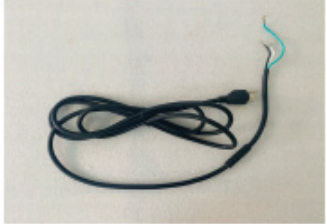
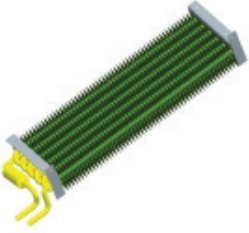
32	R7.01.40080	Back Cover; DSP29-12M	
33	R4.02.10002	Hinge; S/S; Upper Right; 45*23; Compatible with All Undercounters and Salad Prep Tables	
34	R2.09.10003	Wiring Harness; Power Cord; NEMA 5-15P; 3*16AWG; 2.7M	
35	R5.01.10013	Evaporator; 2R6K400L_WX	

Un producto:



METALGAS, S.R.L.

Calidad, servicio y garantía

Más de 35 años acompañando tus negocios

📍 Av. Luperón no.5, Zona Industrial de Herrera
📍 Autopista de San Isidro, 1^{er} nivel Coral Mall. Santo Domingo Este