

Platinum

Modern Chef
La cocina perfecta

*Lista de piezas mesa refrigerada preparación de sandwich
MGSP48 - 2 puertas*

**MESA
REFRIGERADA
PREPARACIÓN
DE SANDWICH**



WWW.METALGAS.COM.DO

Un producto:

MG METALGAS, S.R.L.

Calidad, servicio y garantía

Más de 35 años acompañando tus negocios

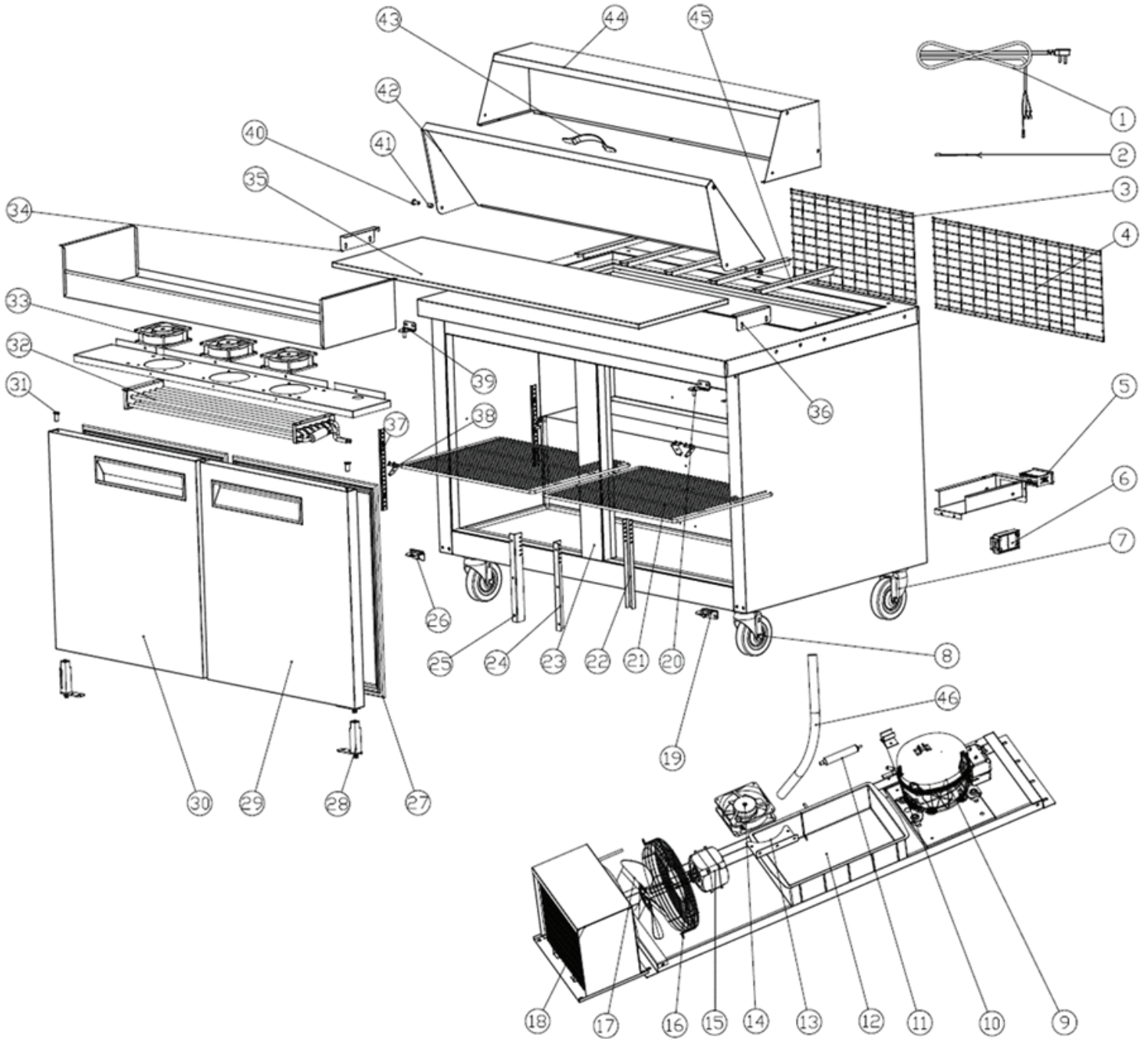

 Av. Luperón no.5, Zona Industrial de Herrera
 Autopista de San Isidro, 1^{er} nivel Coral Mall. Santo Domingo Este



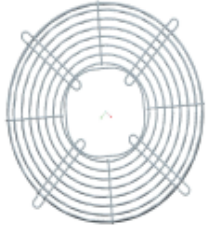
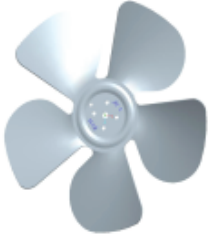
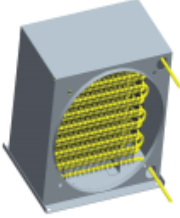

| No. | Number | Description | Photo |
|-----|-------------|---|---|
| 1 | R2.09.10003 | Wiring Harness; Power Cord; NEMA 5-15P; 3*16AWG; 2.7M |  |
| 2 | R2.11.10006 | Probe Wire; 3435/10KΩ; 2.5M/With Terminals/Black |  |
| 3 | R4.04.30024 | Back Grid; Salad Prep Table; 486*268 |  |
| 4 | R4.04.30023 | Back Grid; Salad Prep Table; 669*268 |  |
| 5 | R2.03.10001 | Thermostat XR03CX-4N6F7 |  |

| | | | |
|----|-------------|---|---|
| 6 | R2.08.10001 | Junction Box; ET0301G; UL Certified |  |
| 7 | R4.03.10014 | 5 Inches Black PP Wheel; A2-125S-102 |  |
| 8 | R4.03.10015 | 5 Inches Black PP Wheel with Brake; A2-125S3-102 |  |
| 9 | R2.01.20001 | Compressor; NUT45NR |  |
| 10 | R4.99.10019 | Filter Clip |  |

| | | | |
|----|-------------|--|---|
| 11 | R5.03.20003 | Filter Drier; Bypass Φ 2.5*6.2-135 |  |
| 12 | R3.01.30003 | Drainage Pan #5 |  |
| 13 | R7.01.40093 | Outer Drain Pan Supporting Plate |  |
| 14 | R2.02.20007 | Fan Motor SAA12038B2H |  |
| 15 | R2.02.10002 | Fan Motor YZ10-20 |  |

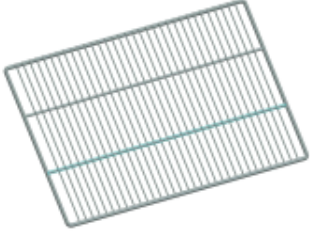
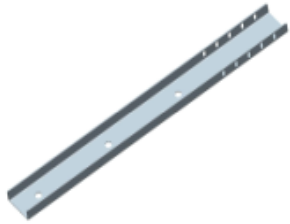
| | | | |
|----|-------------|--|---|
| 16 | R4.04.50002 | Fan Guard, Ø230; 40H |  |
| 17 | R4.07.10005 | Fan Blade ø 230; 28° |  |
| 18 | R5.02.20049 | Condenser; 6 layers; 240L235H |  |
| 19 | R4.02.10006 | Hinge; S/S; Lower Right; 50*26; Compatible with All Undercounters and Salad Prep Tables |  |
| 20 | R4.02.10002 | Hinge; S/S; Upper Right; 45*23; Compatible with All Undercounters and Salad Prep Tables |  |

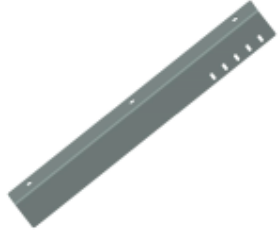
| | | | |
|----|-------------|------------------------------------|---|
| 21 | R4.04.10079 | Shelf; TFP48; 534*410 |  |
| 22 | R7.01.40092 | Back K-strip |  |
| 23 | R7.01.40087 | Foaming Vertical Beam; DUCR/DSP |  |
| 24 | R7.01.40091 | Right K-strip Middle Beam |  |
| 25 | R7.01.40090 | Left K-strip Middle Beam |  |

| | | | |
|----|-------------|---|---|
| 26 | R4.02.10005 | <p>Hinge; S/S; Lower Left; 50*26; Compatible with All Undercounters and Salad Prep Tables</p> |  |
| 27 | R7.01.40063 | Gasket DSP48/DUC48 |  |
| 28 | R4.08.30001 | <p>Self-closing Hinge; 22*22*100</p> |  |
| 29 | R7.01.40056 | Right Foaming Door DSP48/DUC48 |  |
| 30 | R7.01.40055 | Left Foaming Door DSP48/DUC48 |  |

| | | | |
|----|-------------|--|---|
| 31 | R3.01.50008 | <p>Axis Guide; Nylon; ϕ 7*25</p> |  |
| 32 | R5.01.10014 | <p>Evaporator; 2R6K660L_WX</p> |  |
| 33 | R2.02.20007 | <p>Fan Motor SAA12038B2H</p> |  |
| 34 | R7.01.40066 | <p>Left Fixed Block for Cutting Board</p> |  |
| 35 | R3.03.10002 | <p>Cutting Board; 1222*225*15</p> |  |

| | | | |
|----|-------------|---|---|
| 35 | R3.03.10006 | Cutting Board; 1222*370*15 |  |
| 36 | R7.01.40067 | Right Fixed Block for Cutting Board |  |
| 37 | R4.06.20001 | K-strip; 2 holes; Length:238.3 |  |
| 38 | R4.06.10001 | K-clip; 22*27.2 |  |
| 39 | R4.02.10001 | Hinge; S/S; Upper Left; 45*23; Compatible with All Undercounters and Salad Prep Tables |  |

| | | | |
|----|-------------|---|---|
| 40 | R4.02.10035 | Hinge; S/S; Pan Cover Pin (Throughhole); 20L |  |
| 41 | R4.99.10023 | Limit Tube for Pan Cover; $\phi 10^* \phi 9^*15$ |  |
| 42 | R7.01.40072 | Pan Cover DSP48-12 |  |
| 42 | R7.01.40077 | Pan Cover DSP48-18M |  |
| 43 | R4.12.40001 | Handle; Locating Distance 128 |  |

| | | | |
|----|-------------|---|---|
| 44 | R7.01.40081 | Back Cover; DSP48-12 |  |
| 44 | R7.01.40082 | Back Cover; DSP48-18M |  |
| 45 | R7.01.40069 | Vertical GN Pan Bracket; 324L; Regular_TOP |  |
| 45 | R7.01.40068 | Vertical GN Pan Bracket; 529L; MEGA_TOP |  |
| 46 | R7.01.40089 | PVC Reticulated Duct; ϕ 23* ϕ 19*300 |  |

Un producto:



METALGAS, S.R.L.

Calidad, servicio y garantía

Más de 35 años acompañando tus negocios

 Av. Luperón no.5, Zona Industrial de Herrera
 Autopista de San Isidro, 1^{er} nivel Coral Mall. Santo Domingo Este