

Platinum

Modern Chef
La cocina perfecta

*Lista de piezas mesa refrigerada preparación de sandwich
MGSP60 - 2 puertas*

**MESA
REFRIGERADA
PREPARACIÓN
DE SANDWICH**



WWW.METALGAS.COM.DO

Un producto:

MG METALGAS, S.R.L.

Calidad, servicio y garantía

Más de 35 años acompañando tus negocios

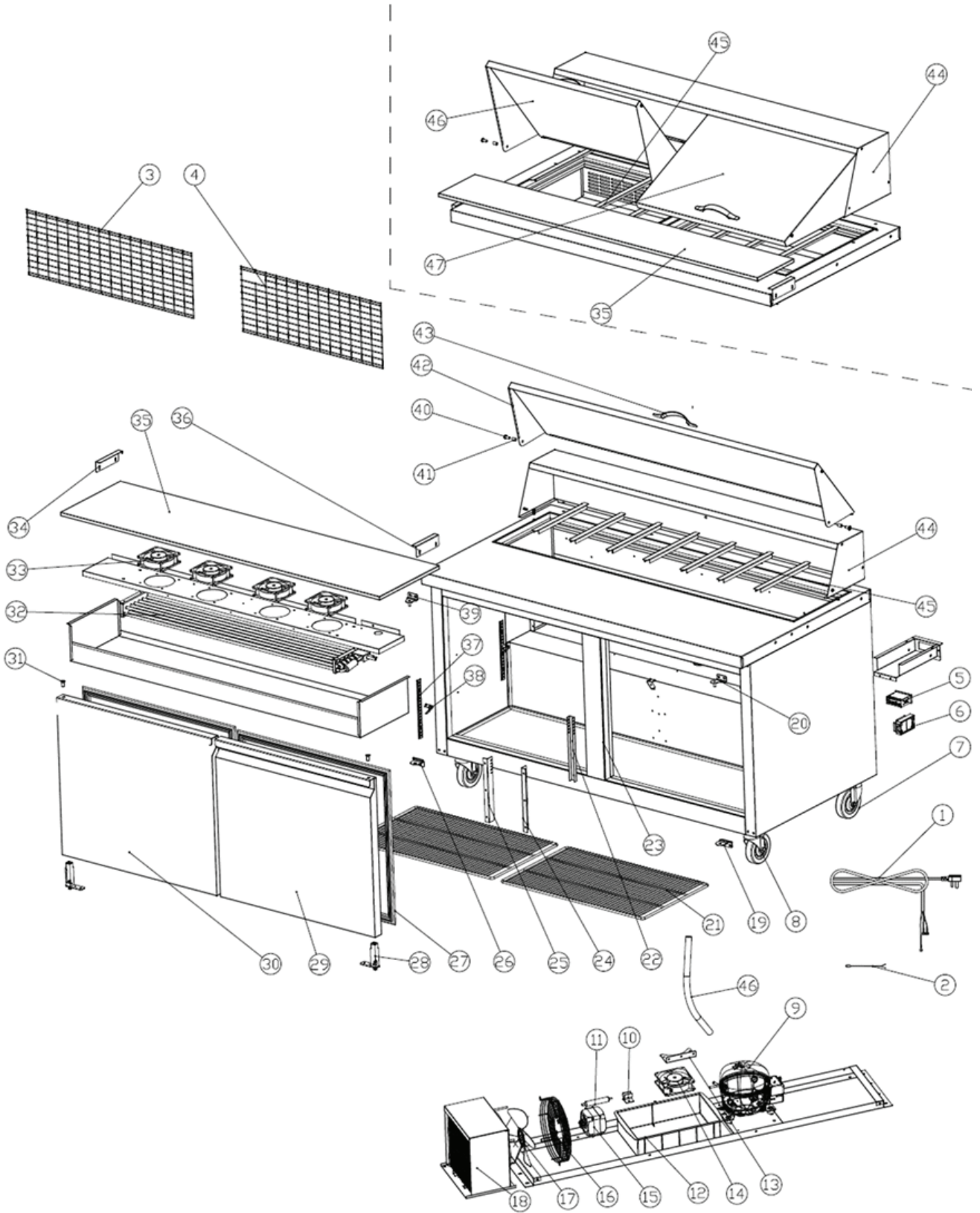

📍 Av. Luperón no.5, Zona Industrial de Herrera
📍 Autopista de San Isidro, 1^{er} nivel Coral Mall. Santo Domingo Este



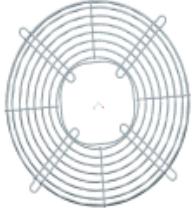
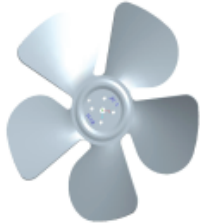
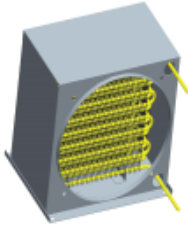

NO.	Number	Description	Photo
1	R2.09.10003	Wiring Harness; Power Cord; NEMA 5-15P; 3*16AWG; 2.7M	
2	R2.11.10006	Probe Wire; 3435/10KΩ; 2.5M/With Terminals/Black	
3	R4.04.30025	Back Grid; Salad Prep Table; 788*268	
4	R4.04.30023	Back Grid; Salad Prep Table; 669*268	
5	R2.03.10001	Thermostat XR03CX- 4N6F7	

6	R2.08.10001	Junction Box; ET0301G; UL Certified	
7	R4.03.10014	5 Inches Black PP Wheel; A2-125S-102	
8	R4.03.10015	5 Inches Black PP Wheel with Brake; A2-125S3-102	
9	R2.01.20001	Compressor; NUT45NR	
10	R4.99.10019	Filter Clip	

11	R5.03.20003	Filter Drier; Bypass $\Phi 2.5 \times 6.2-135$	
12	R3.01.30003	Drainage Pan #5	
13	R7.01.40093	Outer Drain Pan Supporting Plate	
14	R2.02.20007	Fan Motor SAA12038B2H	
15	R2.02.10002	Fan Motor YZ10-20	

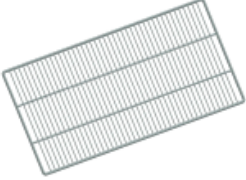
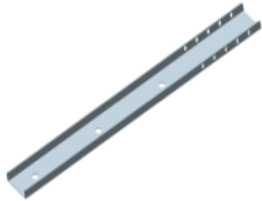
16	R4.04.50002	Fan Guard, Ø230; 40H	
17	R4.07.10005	Fan Blade ø 230; 28°	
18	R5.02.20049	Condenser; 6 layers; 240L235H	
19	R4.02.10006	Hinge; S/S; Lower Right; 50*26; Compatible with All Undercounters and Salad Prep Tables	
20	R4.02.10002	Hinge; S/S; Upper Right; 45*23; Compatible with All Undercounters and Salad	

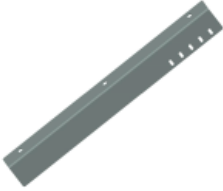

21	R4.04.10080	Shelf; TFP60; 684*410	
22	R7.01.40092	Back K-strip	
23	R7.01.40087	Foaming Vertical Beam; DUCR/DSP	
24	R7.01.40091	Right K-strip Middle Beam	
25	R7.01.40090	Left K-strip Middle Beam	

26	R4.02.10005	<p>Hinge; S/S; Lower Left; 50*26; Compatible with All Undercounters and Salad Prep Tables</p>	
27	R7.01.40064	Gasket DSP60/DUC60	
28	R4.08.30001	<p>Self-closing Hinge; 22*22*100</p>	
29	R7.01.40058	Right Foaming Door DSP60/DUC60	
30	R7.01.40057	Left Foaming Door DSP60/DUC60	

31	R3.01.50008	Axis Guide; Nylon; ϕ 7*25	
32	R5.01.10015	Evaporator; 2R6L1000L_WX	
33	R2.02.20007	Fan Motor SAA12038B2H	
34	R7.01.40066	Left Fixed Block for Cutting Board	
35	R3.03.10003	Cutting Board; 1524*225*15	

35	R3.03.10007	Cutting Board; 1524*370*15	
36	R7.01.40067	Right Fixed Block for Cutting Board	
37	R4.06.20001	K-strip; 2 holes; Length:238.3	
38	R4.06.10001	K-clip; 22*27.2	
39	R4.02.10001	Hinge; S/S; Upper Left; 45*23; Compatible with All Undercounters and Salad Prep Tables	

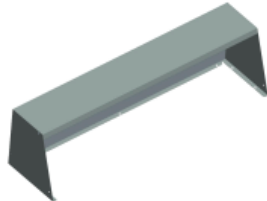
40	R4.02.10035	Hinge; S/S; Pan Cover Pin (Throughhole); 20L	
41	R4.99.10023	Limit Tube for Pan Cover; $\phi 10 * \phi 9 * 15$	
42	R7.01.40073	Pan Cover DSP60-16	
43	R4.12.40001	Handle; Locating Distance 128	
44	R7.01.40083	Back Cover; DSP60-1	

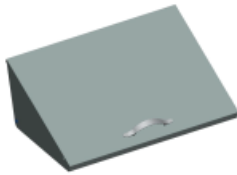
44	R7.01.40084	Back Cover; DSP60-24M	
45	R7.01.40069	Vertical GN Pan Bracket; 324L; Regular_TOP	
45	R7.01.40068	Vertical GN Pan Bracket; 529L; MEGA_TOP	
46	R7.01.40076	Pan Cover DSP29- 12M/DSP60-24M (Left)	
47	R7.01.40078	Right Pan Cover DSP60- 24M/DSP72-30M (Right)	

Un producto:



Calidad, servicio y garantía

Más de 35 años acompañando tus negocios

 Av. Luperón no.5, Zona Industrial de Herrera
 Autopista de San Isidro, 1^{er} nivel Coral Mall. Santo Domingo Este